



Quick Start Guide

BESTMOW T100 Robotic Lawn Mower



GET IT ON
Google Play



Download on the
App Store

Unboxing

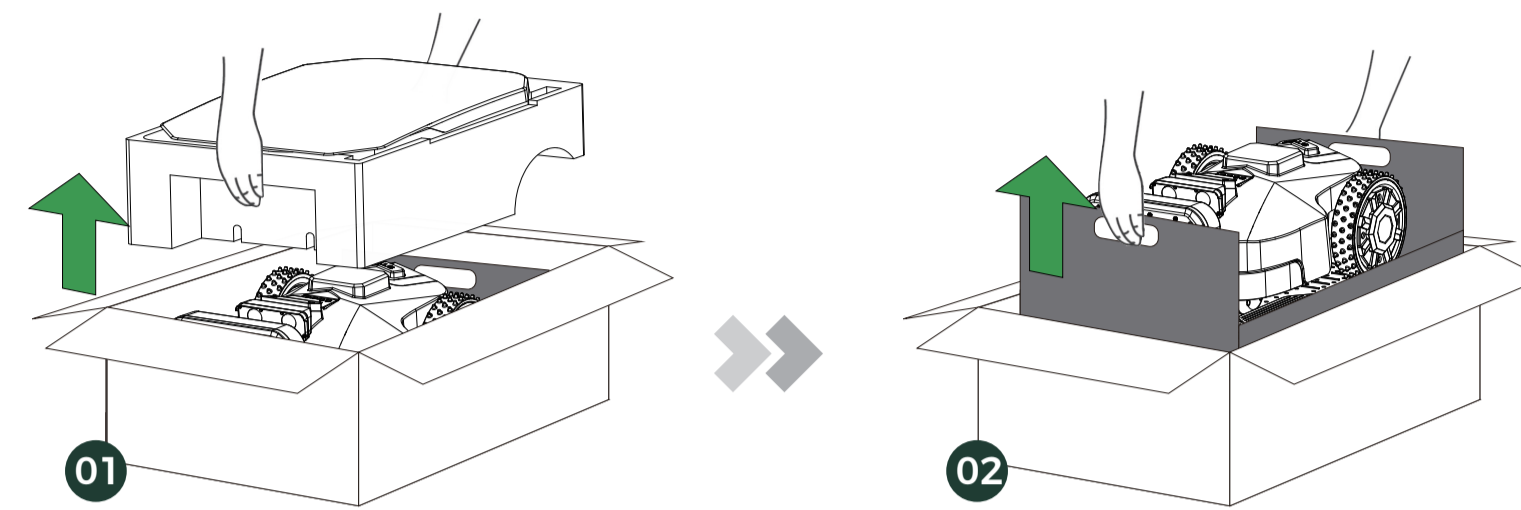

What's inside the box

 Garage (*Optional) x1	 Ground Peg x10	 Screw x8	 Power Adapter x1	 Screwdriver x1
 Blade Disc x1	 Blade Set x1 (including 12 blades)	 Blade Installation Fixture x1	 User Manual x1	 Stake x15
 Cable Ties x5	 Drag and Mow Tool x1			

Charging Pile Installation

Attention!

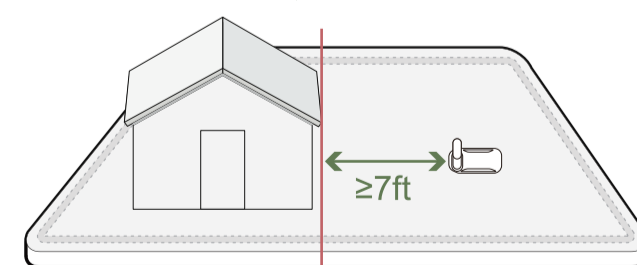

Distance between devices and Roofline

Attention!

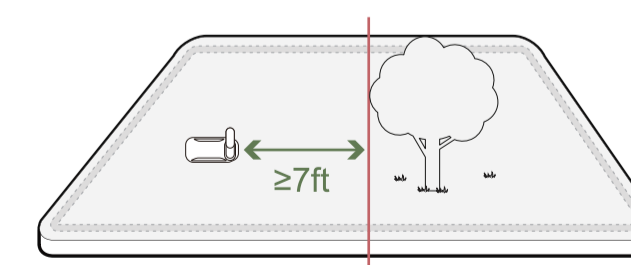

Distance between the device and the tree canopy

- 01 Select a location with strong Wi-Fi signal coverage.
- 02 Ensure the charging station is placed on level ground for optimal docking.

Assemble the Garage

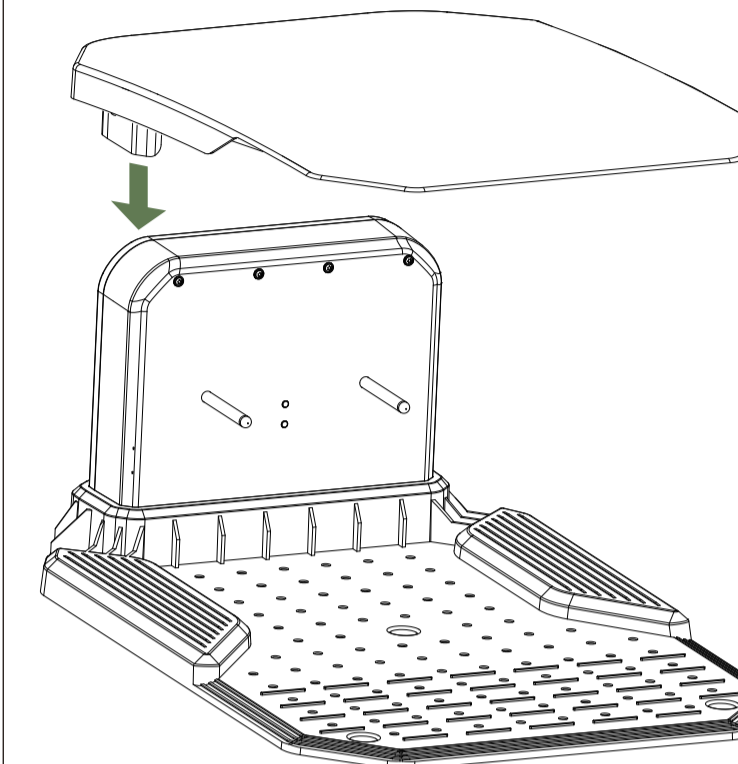

Screw on

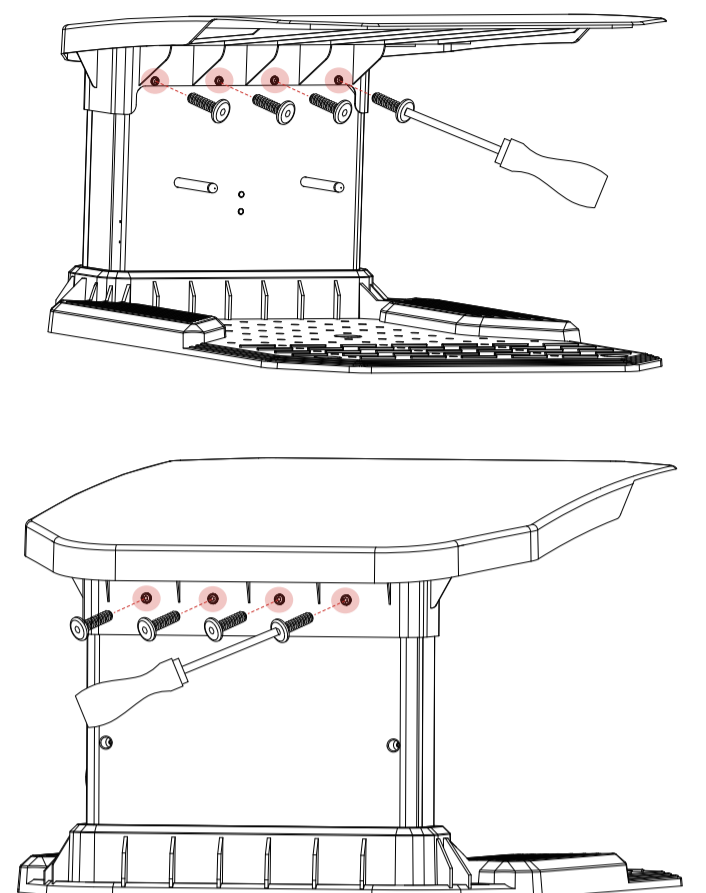

The garage is an optional accessory. Please refer to the items included in your package. The mower's waterproof performance is not affected by the presence or absence of the garage.

Connection

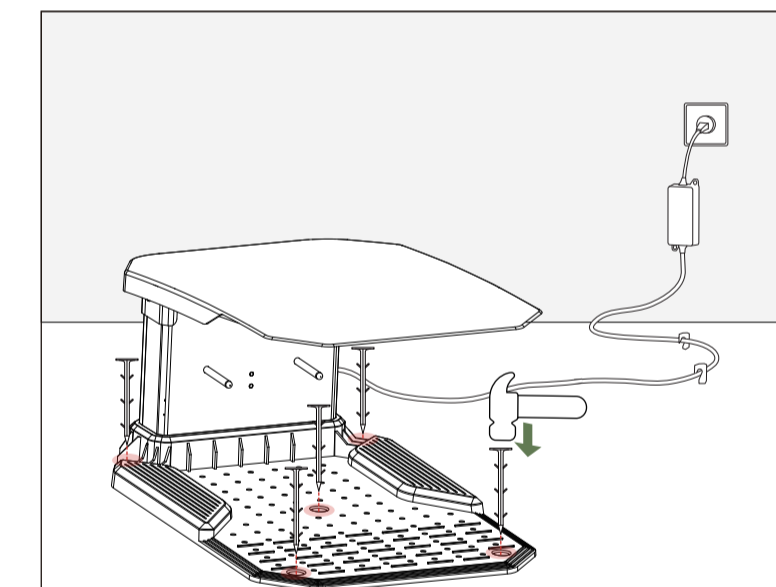

01 Power the charging pile

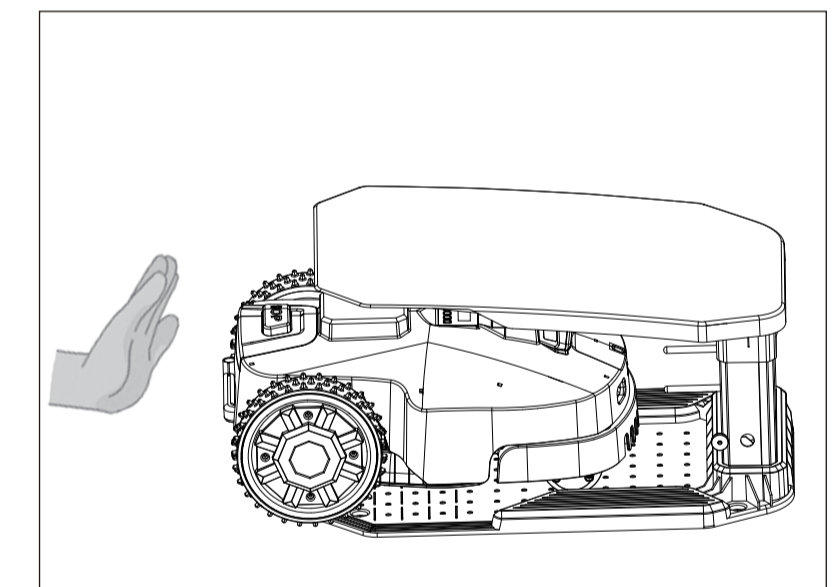

02 Place BESTMOW on charging pile

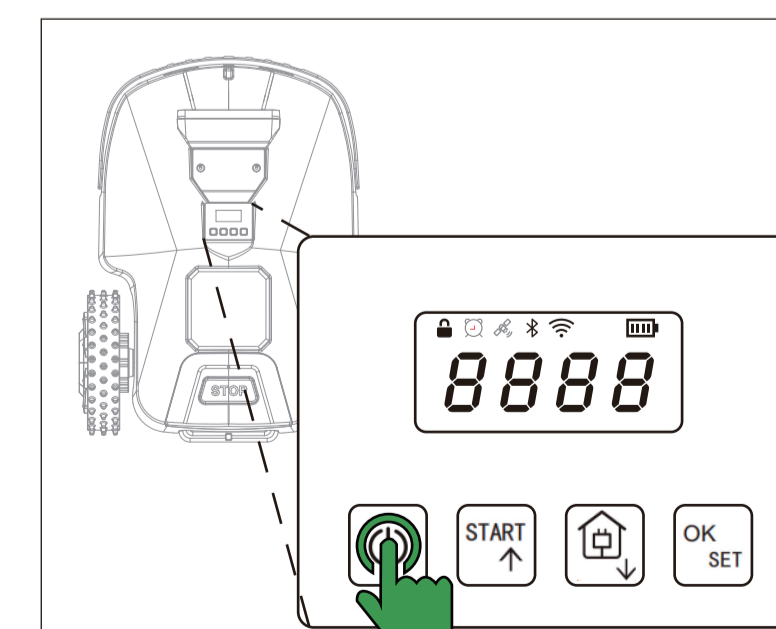

03 If BESTMOW does not automatically turn on, please manually turn it on

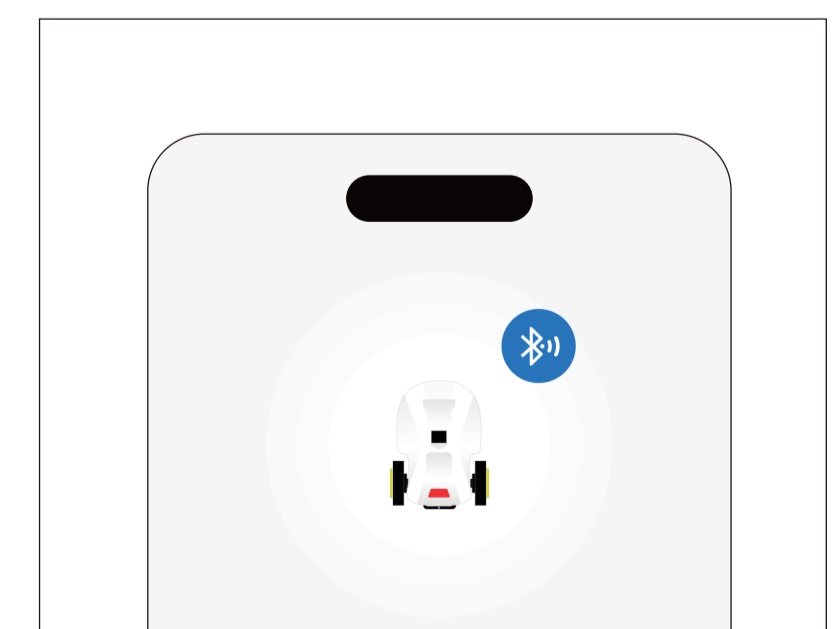

04 Follow the APP prompts for set up

App-Driven Mapping Mode

Create a map

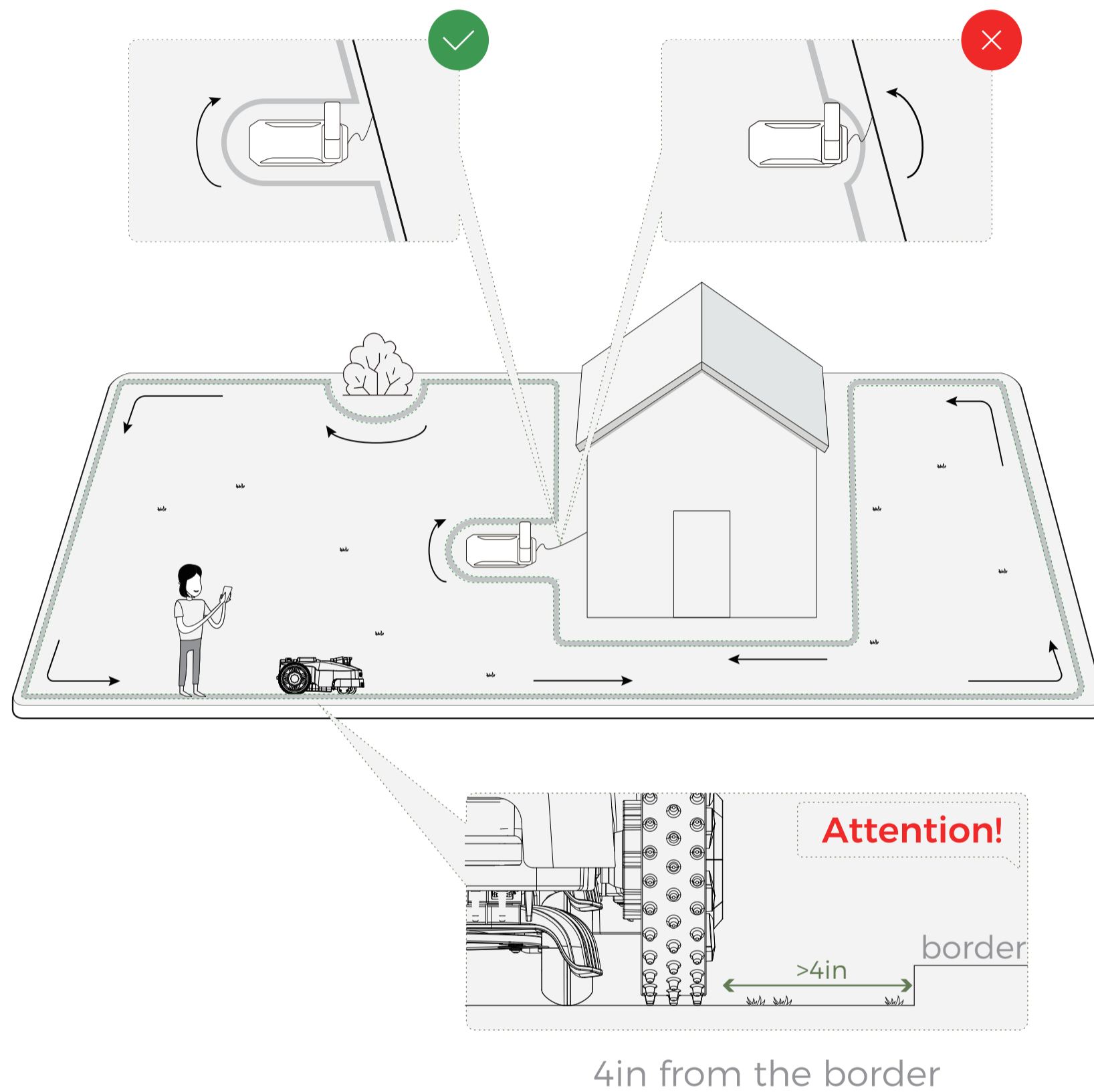

- 01 Remove debris, piles of leaves, toys, wires, stones and other obstacles. Make sure children and pets are off the lawn.
- 02 Draw the map along the lawn boundary.
- 03 Once correct, click "DONE".
- 04 The system will automatically detect pathways between mowing zones.

Drag Mapping Mode

Use the drag and mow tool to drag along the edge of the lawn to complete mapping.

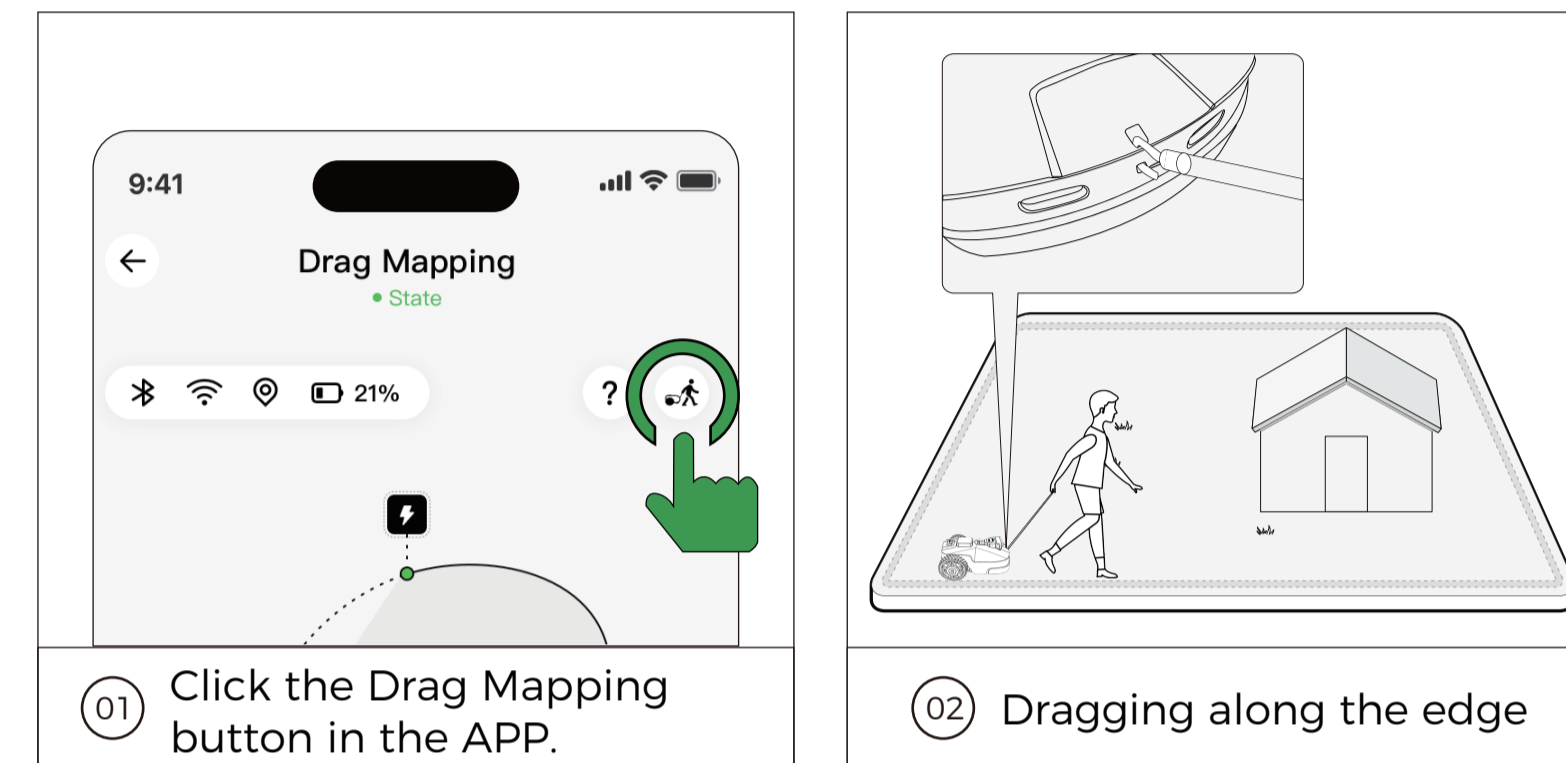

Mapping Obstacles

Obstacles avoidance example

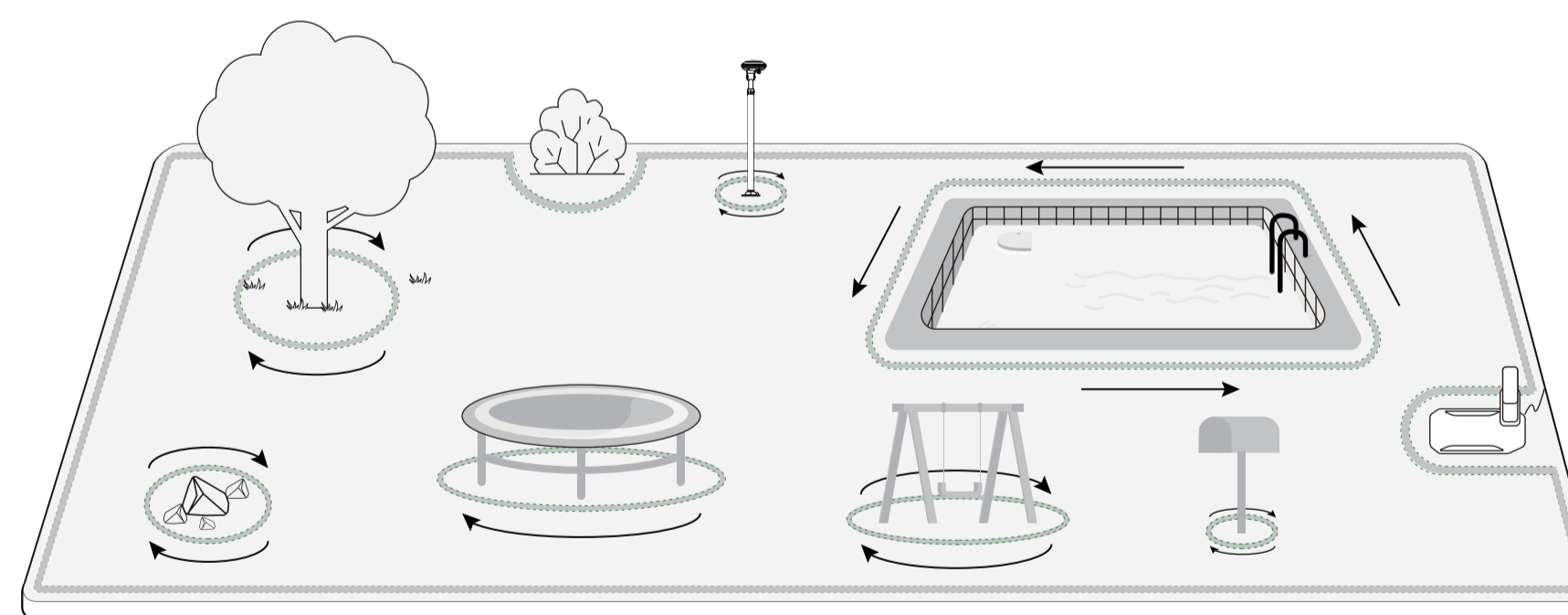

- 01 Identify the large fixed obstacles, then start from any position, using App-Driven mode or Drag mode to circle the outline of the area.
- 02 Make smooth turning angles when setting the islands. The angles should not be smaller than 90°. Make sure to walk along the edge when setting the islands.

Customer Support

Contact Us

TEL:
1 800-882-2131

Email:
support@bestmow.com



[Installation Video](#)



WWW.BESTMOW.COM

Follow Us



tiktok.com/@bestmow
tiktok.com/@bestmow_north_america
tiktok.com/@bestmow_offical



youtube.com/@bestmow



facebook.com/BESTMOWROBOT



instagram.com/bestmow